

CONTROLLER/MANIFOLD AREA

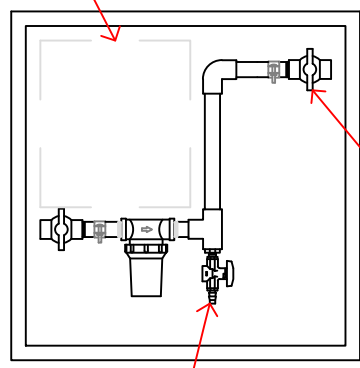

ISOLATION VALVE

SAMPLE VALVE

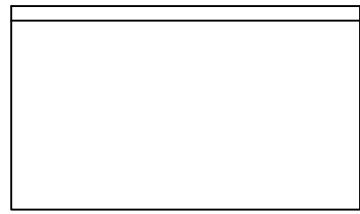

NOTES:
 INLET, OUTLET, WINDOW AND MOUNTING DIMENSIONS ARE BASED ON STANDARD PRODUCTS. FINISHED DIMENSIONS MAY VARY BASED ON PRODUCT INSTALLED.

MATERIALS:
 EPOXY PAINTED CARBON STEEL ENCLRSRE, LEXAN WINDOW, PVC MANIFOLD, PVC TEFLON BALL VALVES, POLYPROPYLENE BOWL STRAINER

Capacity:	N/A	Gallons
Max Temp.:	85	F
Max Press.:	150	PSI
Weight:	130	Lbs.
Voltage.:	115 VAC	1 Phs 60 Hz
FLA.:	6	amps

20	x	x
19	x	x
18	x	x
17	x	x
16	x	x
15	x	x
14	x	x
13	x	x
12	x	x
11	x	x
10	x	x
9	x	x
8	x	x
7	x	x
6	x	x
5	x	x
4	x	x
3	x	x
2	x	x
1	x	x

#	PART	DESCRIPTION
F	x	xx/xx/xx
E	x	xx/xx/xx
D	x	xx/xx/xx
C	x	xx/xx/xx
B	x	xx/xx/xx

General Treatment Products, Inc.
 PO Box 8697, Brea, CA 92822
 Phone: 714) 257-9165 <http://www.gtpcompany.com>
 Fax: 714) 257-9215 customerservice@gtpcompany.com

Date: 1/1/2019 Scale: NTS Rev.: A

Description:
 24x24 WALL MOUNT ENCLOSURE

Model:
 CF-WCxx CB24

NOTICE: This drawing and its contents are for the specific use of GTP customers only. It is not to be duplicated or copied without expressed written consent of General Treatment Products, Inc. We reserve the right to modify this drawing without notice.

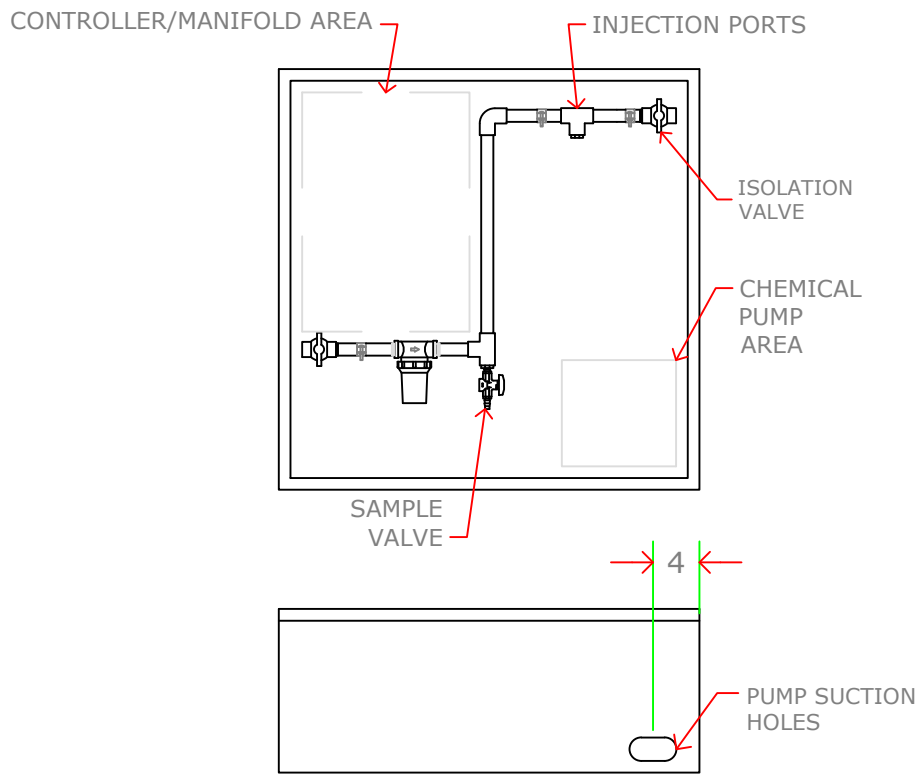
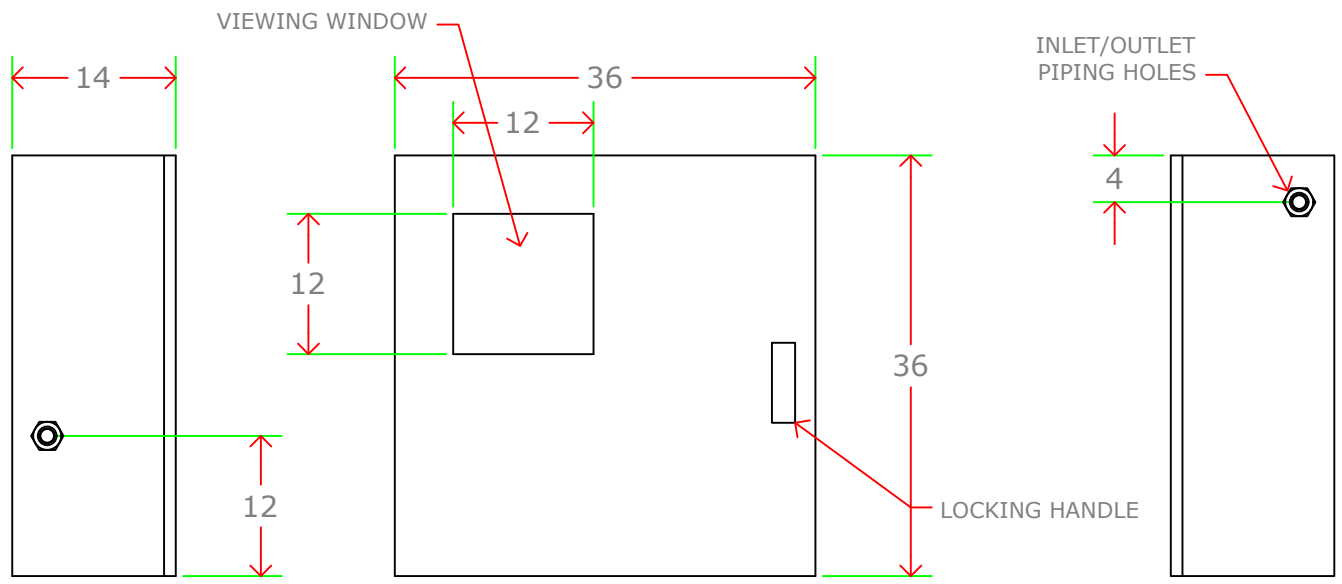
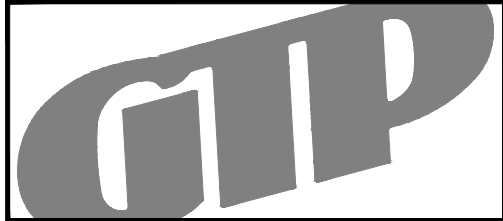

NOTES:
 INLET, OUTLET, WINDOW AND MOUNTING DIMENSIONS ARE BASED ON STANDARD PRODUCTS. FINISHED DIMENSIONS MAY VARY BASED ON PRODUCT INSTALLED.

MATERIALS:
 EPOXY PAINTED CARBON STEEL ENCLSR, LEXAN WINDOW, PVC MANIFOLD, PVC TEFLON BALL VALVES, POLYPROPYLENE BOWL STRAINER

Capacity:	N/A	Gallons
Max Temp.:	85	F
Max Press.:	150	PSI
Weight:	185	Lbs.
Voltage.:	115 VAC	1 Phs 60 Hz
FLA.:	6	amps

20	x	x
19	x	x
18	x	x
17	x	x
16	x	x
15	x	x
14	x	x
13	x	x
12	x	x
11	x	x
10	x	x
9	x	x
8	x	x
7	x	x
6	x	x
5	x	x
4	x	x
3	x	x
2	x	x
1	x	x

#	PART	DESCRIPTION
F	x	xx/xx/xx
E	x	xx/xx/xx
D	x	xx/xx/xx
C	x	xx/xx/xx
B	x	xx/xx/xx
REV	DESCRIPTION	DATE

General Treatment Products, Inc.
 PO Box 8697, Brea, CA 92822
 Phone: 714) 257-9165 <http://www.gtpcompany.com>
 Fax: 714) 257-9215 customerservice@gtpcompany.com

Date: 1/1/2019 Scale: NTS Rev.: A

Description:
 36X36 WALL MOUNT ENCLOSURE

Model:
 CF-WCxx CB36

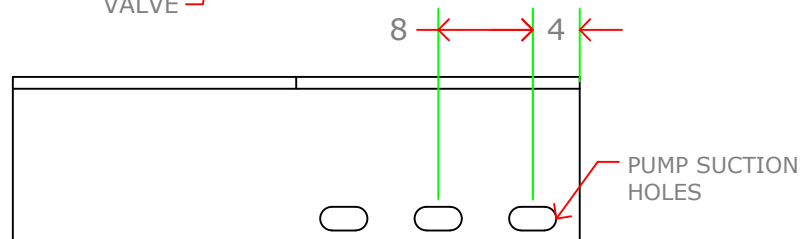
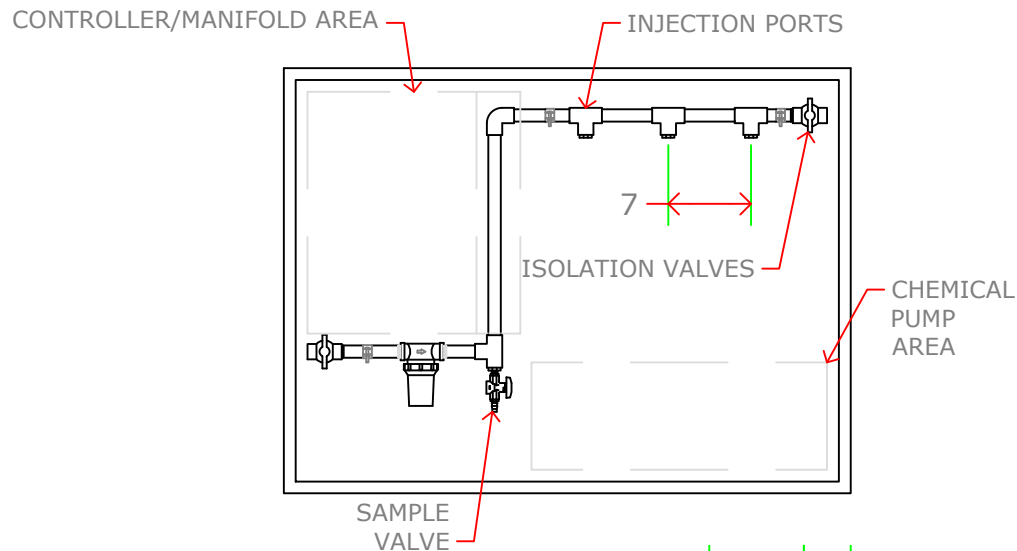
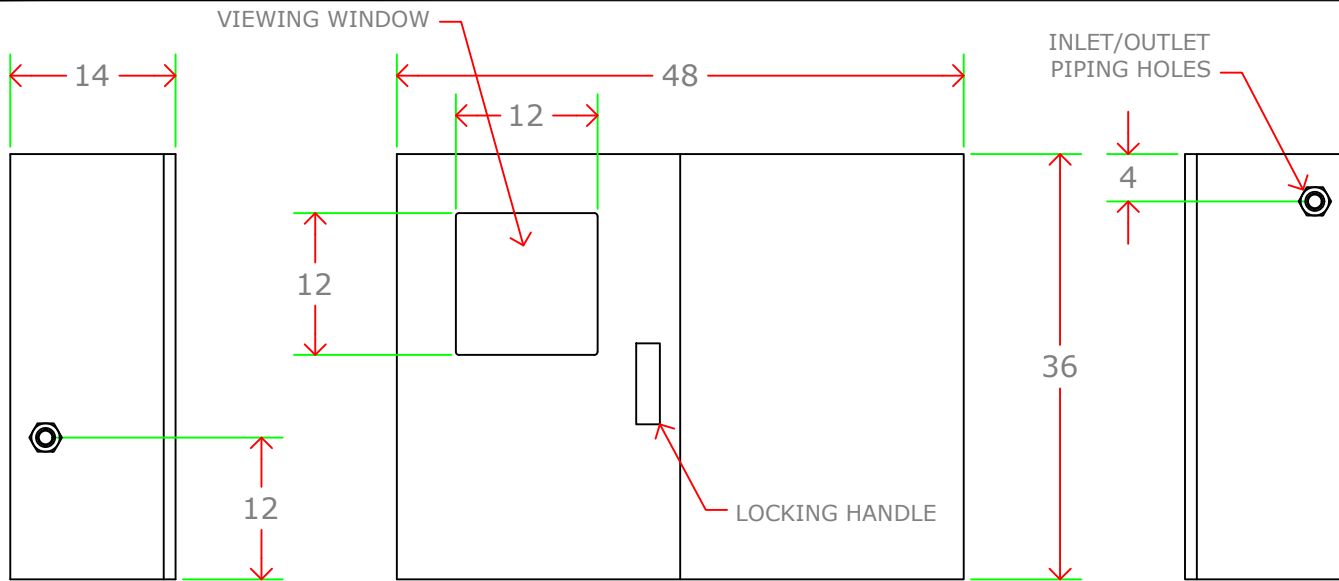
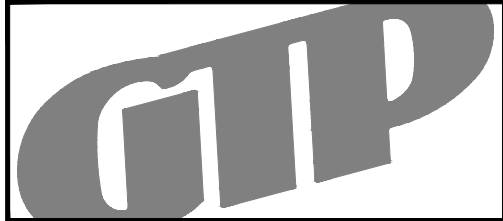

NOTES:

INLET, OUTLET, WINDOW AND MOUNTING DIMENSIONS ARE BASED ON STANDARD PRODUCTS. FINISHED DIMENSIONS MAY VARY BASED ON PRODUCT INSTALLED.

MATERIALS:

EPOXY PAINTED CARBON STEEL ENCLSR, LEXAN WINDOW, PVC MANIFOLD, PVC TEFLON BALL VALVES, POLYPROPYLENE BOWL STRAINER

Capacity:	N/A	Gallons
Max Temp.:	85	F
Max Press.:	150	PSI
Weight:	210	Lbs.
Voltage.:	115 VAC	1 Phs 60 Hz
FLA.:	6	amps

20	x	x
19	x	x
18	x	x
17	x	x
16	x	x
15	x	x
14	x	x
13	x	x
12	x	x
11	x	x
10	x	x
9	x	x
8	x	x
7	x	x
6	x	x
5	x	x
4	x	x
3	x	x
2	x	x
1	x	x

#	PART	DESCRIPTION
F	x	xx/xx/xx
E	x	xx/xx/xx
D	x	xx/xx/xx
C	x	xx/xx/xx
B	x	xx/xx/xx

General Treatment Products, Inc.
 PO Box 8697, Brea, CA 92822
 Phone: 714) 257-9165 <http://www.gtpcompany.com>
 Fax: 714) 257-9215 customerservice@gtpcompany.com

Date: 1/1/2019 Scale: NTS Rev.: A

Description: 36X48 WALL MOUNT ENCLOSURE

Model: CF-WCxx CB48

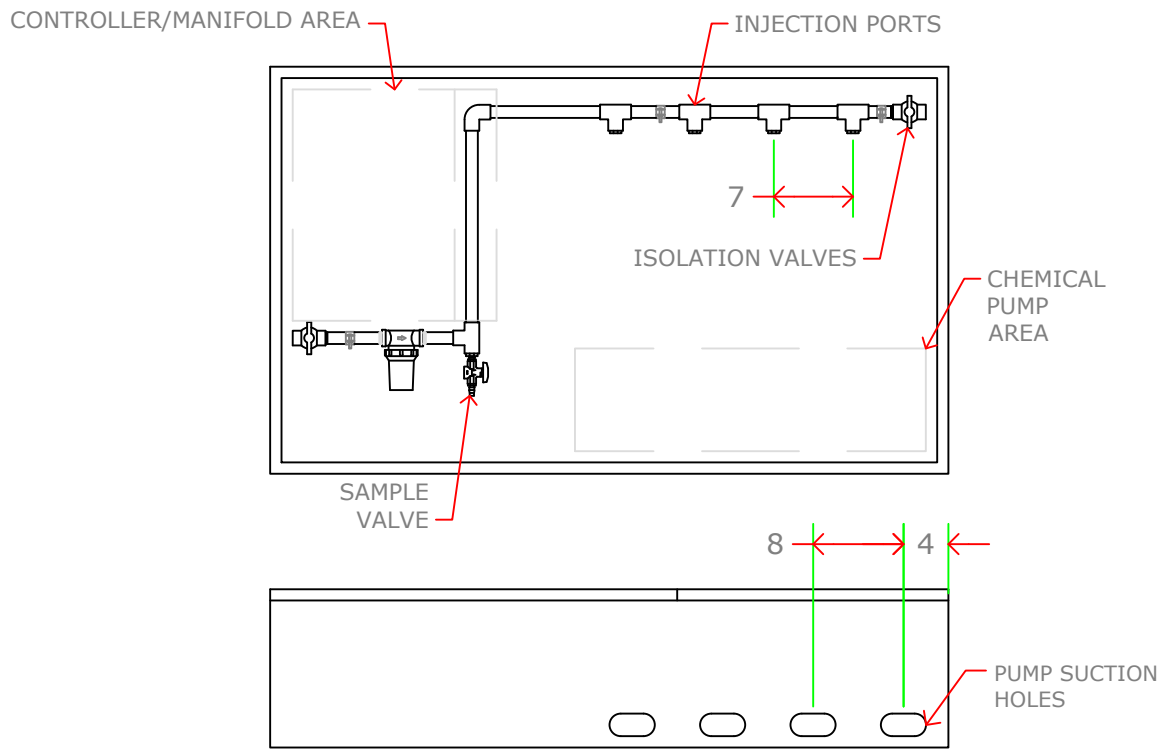
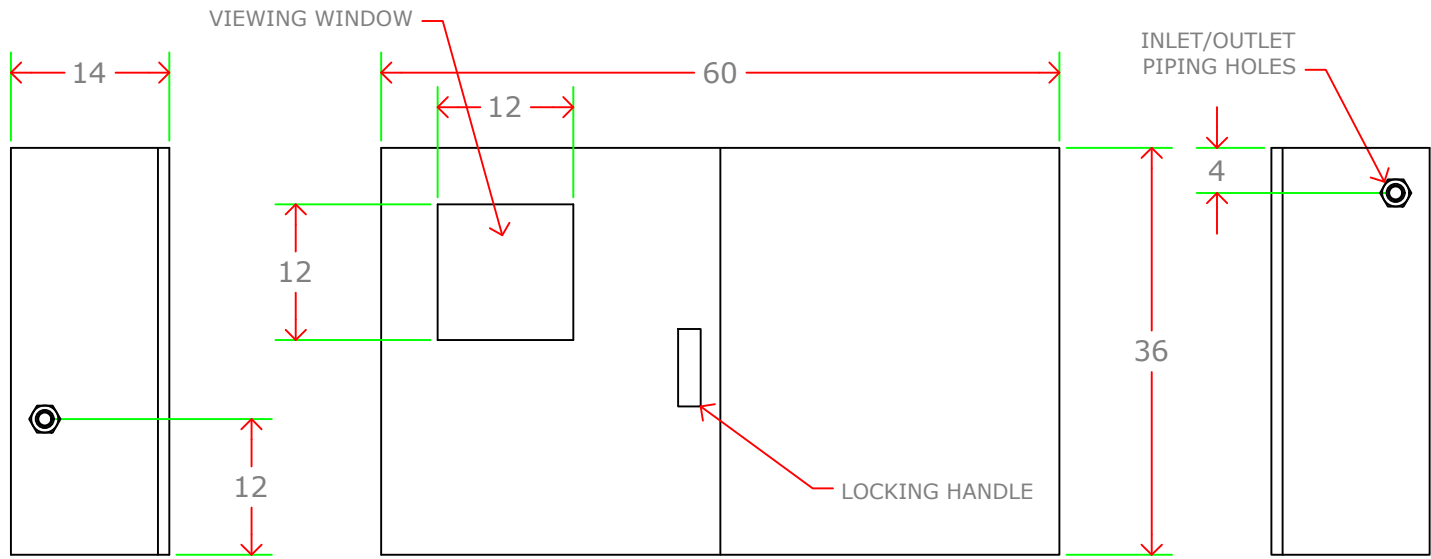
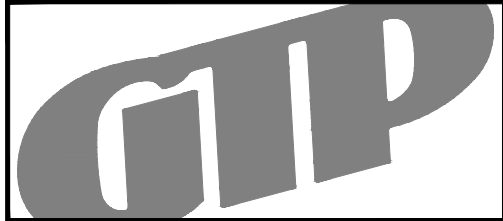

NOTES:
 INLET, OUTLET, WINDOW AND MOUNTING DIMENSIONS ARE BASED ON STANDARD PRODUCTS. FINISHED DIMENSIONS MAY VARY BASED ON PRODUCT INSTALLED.

MATERIALS:
 EPOXY PAINTED CARBON STEEL ENCLSR, LEXAN WINDOW, PVC MANIFOLD, PVC TEFLON BALL VALVES, POLYPROPYLENE BOWL STRAINER

Capacity:	N/A	Gallons
Max Temp.:	85	F
Max Press.:	150	PSI
Weight:	265	Lbs.
Voltage.:	115 VAC	1 Phs 60 Hz
FLA.:	6	amps

20	x	x
19	x	x
18	x	x
17	x	x
16	x	x
15	x	x
14	x	x
13	x	x
12	x	x
11	x	x
10	x	x
9	x	x
8	x	x
7	x	x
6	x	x
5	x	x
4	x	x
3	x	x
2	x	x
1	x	x

#	PART	DESCRIPTION
F	x	xx/xx/xx
E	x	xx/xx/xx
D	x	xx/xx/xx
C	x	xx/xx/xx
B	x	xx/xx/xx

General Treatment Products, Inc.
 PO Box 8697, Brea, CA 92822
 Phone: 714) 257-9165 <http://www.gtpcompany.com>
 Fax: 714) 257-9215 customerservice@gtpcompany.com

Date: 1/1/2019 Scale: NTS Rev.: A
 Description: 36X60 WALL MOUNT ENCLOSURE
 Model: CF-WCxx CB60

NOTICE: This drawing and its contents are for the specific use of GTP customers only. It is not to be duplicated or copied without expressed written consent of General Treatment Products, Inc. We reserve the right to modify this drawing without notice.